

ARTERIENKLEMMEN, PRÄPARIERKLEMMEN
HEMOSTATIC- AND DISSECTING FORCEPS
PINCES HEMOSTATIQUES ET A PREPARATION
PINZAS HEMOSTATICAS Y PARA PREPARACIONES
PINZE EMOSTATICHE E PER PREPARAZIONE

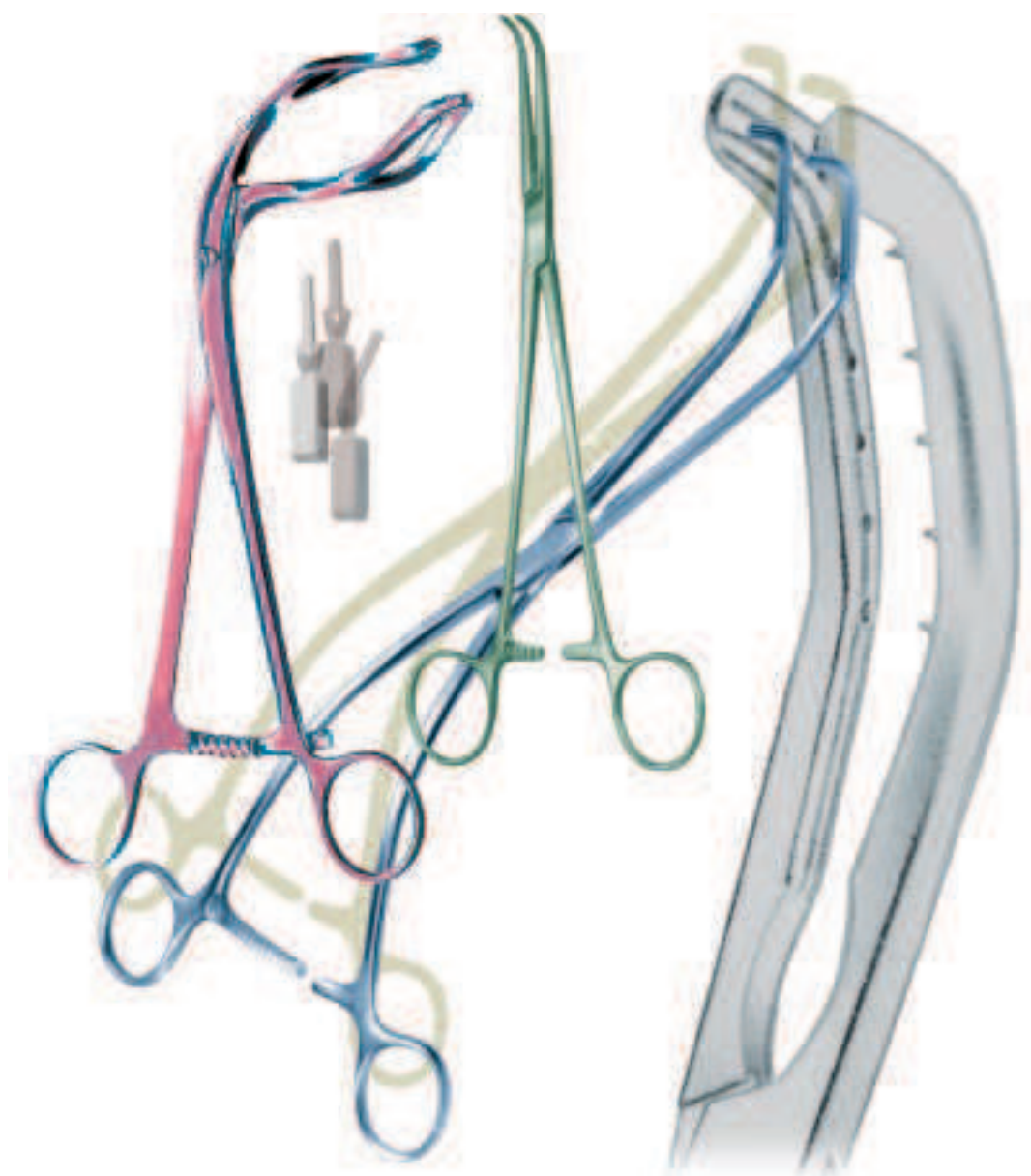

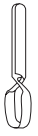

MICRO-CLIP
15.0001
 10 x 2 mm
 60 gr.



MICRO-CLIP
15.0002
 8 x 2 mm
 85 gr.



MICRO-CLIP
15.0003
 6 x 1 mm
 100 gr.



MICRO-CLIP
15.0004
 4 x 0,75 mm
 125 gr.



MICRO-CLIP
15.0005
 6 x 1 mm
 45°, 70 gr.



MICRO-CLIP
15.0006
 6 x 1 mm
 70 gr.



15.0008 14 cm



15.0009 18 cm

Anlegezangen
 applying forceps
 pinces à appliquer
 pinzas para poner
 pinze per applicare



JOHNS-HOPKINS
15.0040 23 cm
 Anlegezange
 applying forceps
 pince à appliquer
 pinza para poner
 pinza per applicare



DIEFFENBACH
15.0010 3,5 cm



DIEFFENBACH
15.0011 3,5 cm



DIEFFENBACH
15.0012 5 cm



DIEFFENBACH
15.0013 5 cm



DIEFFENBACH
15.0014 6 cm

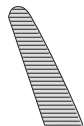

DIEFFENBACH
15.0015 6 cm



JOHNS-HOPKINS
15.0020 38 mm
15.0022 50 mm
15.0024 57 mm
15.0026 63 mm
15.0028 70 mm
15.0030 76 mm
15.0032 90 mm



JOHNS-HOPKINS
15.0021 38 mm
15.0023 50 mm
15.0025 57 mm
15.0027 63 mm
15.0029 70 mm
15.0031 76 mm
15.0033 90 mm



SCHWARTZ
15.0050 25 mm



SCHWARTZ
15.0051 25 mm



SCHWARTZ
15.0053 25 mm



SCHWARTZ
15.0058 19 cm

Anlegezange
Applying forceps
pince à appliquer
pinza para poner
pinza per applicare



MINI-SERREFINE
15.0060 28 mm



MINI-SERREFINE
15.0061 28 mm



GLOVER



GLOVER

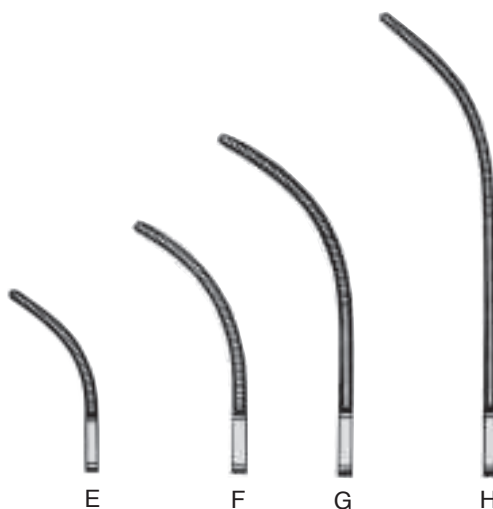

Artikel Item	Fig.	Gesamtlänge Overall length Longeur complet largo total Lunghezza total	Maullänge Jaw length longeur de mors largo de boca Lunghezza del morso	Gewicht Weight Poids Peso Peso
41.0000	A	60 mm	20 mm	5 g
41.0001	E	55 mm	20 mm	5 g
41.0005	B	70 mm	30 mm	9 g
41.0006	F	65 mm	30 mm	9 g
41.0010	C	90 mm	43 mm	12 g
41.0011	G	85 mm	43 mm	12 g
41.0015	D	105 mm	56 mm	14 g
41.0016	H	100 mm	56 mm	14 g
41.0019	J	55 mm	25 mm	7 g



GREGORY

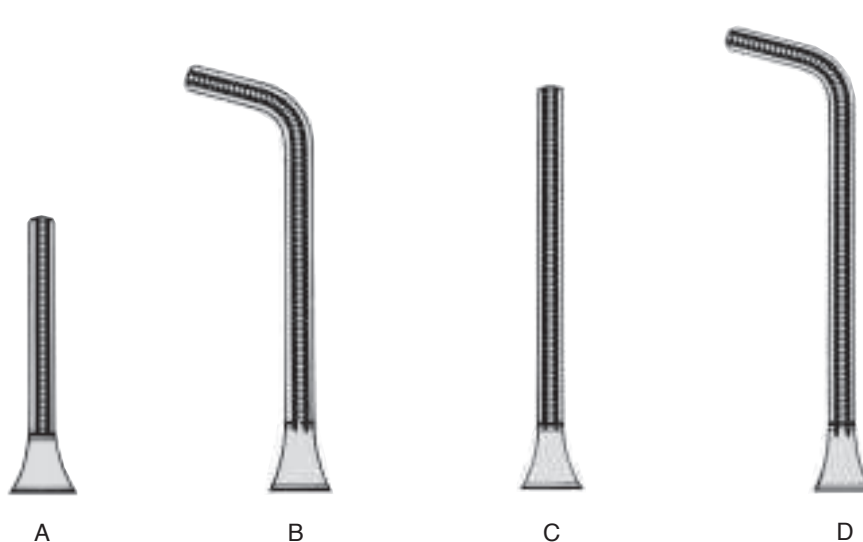

Artikel Item	Fig.	Gesamtlänge Overall length Longeur complet largo total Lunghezza total	Maullänge Jaw length longeur de mors largo de boca Lunghezza del morso	Gewicht Weight Poids Peso Peso
41.0020	A	90 mm	27 mm	11 g
41.0021	B	100 mm	44 mm	12 g
41.0022	C	110 mm	55 mm	12 g
41.0023	D	110 mm	60 mm	12 g



GREGORY

nach links gebogen
 curved to left
 courbe à gauche
 curva a la izquierda
 curvo a sinistra



A

nach rechts gebogen
 curved to right
 courbe à droit
 curva a la derecha
 curvo a destra



B

Artikel Item	Fig.	Gesamtlänge Overall length Longeur complet largo total Lunghezza total	Maullänge Jaw length longeur de mors largo de boca Lunghezza del morso	Gewicht Weight Poids Peso Peso
41.0024	A	110 mm	60 mm	12 g
41.0025	B	110 mm	60 mm	12 g



30 mm Maullänge
 Jaw length
 longueur de mors
 largo de boca
 Lunghezza del morso

SANTULLI
41.0028
 70 mm



A

B

C



D

E

F

G

DIETRICH

Artikel Item	Fig.	Gesamtlänge Overall length Longeur complet largo total Lunghezza total	Maullänge Jaw length longeur de mors largo de boca Lunghezza del morso	Gewicht Weight Poids Peso Peso	Schliesdruck Closing pressure Pression d'Occlusion Presión de cierre Pressione di chiusura
41.0030	A	50 mm	8 mm	3 g	80
41.0031	D	43 mm	8 mm	3 g	80
41.0032	B	53 mm	12 mm	3 g	80
41.0033	E	45 mm	12 mm	3 g	80
41.0034	C	60 mm	20 mm	3 g	80
41.0035	F	50 mm	20 mm	3 g	80
41.0037	G	54 mm	20 mm	3 g	80

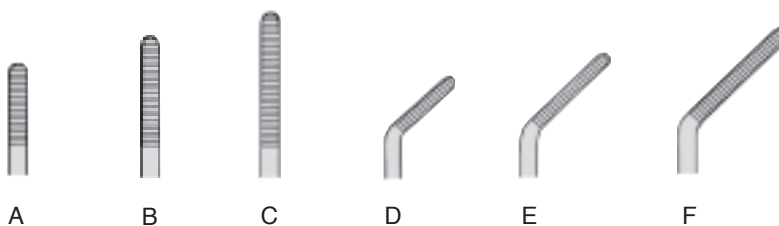

FEDERLEICHT • FEATHERLIGHT • POIDS PLUME • MUY LIGERO

Artikel Item	Fig.	Gesamtlänge Overall length Longeur complet largo total Lunghezza total	Maullänge Jaw length longeur de mors largo de boca Lunghezza del morso	Gewicht Weight Poids Peso Peso	Schliessdruck Closing pressure Pression d'Occlusion Presión de cierre Pressione di chiusura
41.0040	A	31 mm	10 mm	1 g	30
41.0041	B	35 mm	14 mm	1 g	30
41.0042	C	39 mm	18 mm	1 g	30
41.0043	D	30 mm	10 mm	1 g	30
41.0044	E	33 mm	14 mm	1 g	30
41.0045	F	36 mm	18 mm	1 g	30



WICKHAM

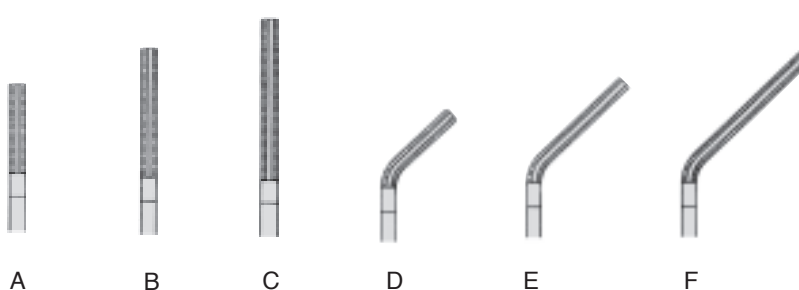

Artikel Item	Fig.	Gesamtlänge Overall length Longeur complet largo total Lunghezza total	Maullänge Jaw length longeur de mors largo de boca Lunghezza del morso	Gewicht Weight Poids Peso Peso	Schliessdruck Closing pressure Pression d'Occlusion Presión de cierre Pressione di chiusura
41.0080	A	49 mm	13 mm	3 g	150
41.0081	D	47 mm	13 mm	3 g	150
41.0082	B	54 mm	18 mm	3 g	150
41.0083	E	51 mm	18 mm	3 g	150
41.0084	C	61 mm	25 mm	3 g	150
41.0085	F	55 mm	25 mm	3 g	150

WICKHAM

41.0089 24 cm

Anlegezange / Applying forceps / Pince à pos / Pinza de aplicación / Pinza per metti-rimovi



TITANIUM

Identification:

A = ARTERIA

= closing force
 220 - 240 ± 10 g

V = VENA

= closing force
 110 - 130 ± 10 g



3,0 cm

41.0050A
 41.0050V



3,5 cm

41.0052A
 41.0052V



4,0 cm

41.0054A
 41.0054V



4,5 cm

41.0056A
 41.0056V

Anlege- u. Entfernungszange für
 TITAN Miniatur-Bulldog-Clips

Applying- and removing Forceps for
 TITAN Miniature Bulldog-Clips

Pinces pour poser et retirer les
 TITAN Clips Bulldog

Pinza para poner y quitar TITAN
 Miniature clips Bulldog

Pinza per metti-rimouvi TITAN
 Clips Bulldog



3,0 cm

41.0051A
 41.0051V



3,5 cm

41.0053A
 41.0053V



4,0 cm

41.0055A
 41.0055V



4,5 cm

41.0057A
 41.0057V



41.0069
 23 cm



3,0 cm

41.0061A
 41.0061V



3,5 cm

41.0063A
 41.0063V



4,0 cm

41.0065A
 41.0065V



4,5 cm

41.0067A
 41.0067V



DEBAKEY-MICRO

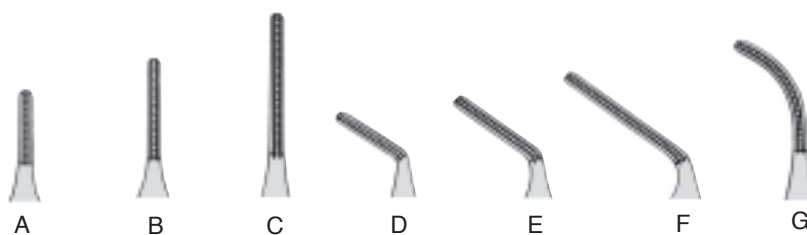

Artikel Item	Fig.	Gesamtlänge Overall length Longeur complet largo total Lunghezza total	Maullänge Jaw length longeur de mors largo de boca Lunghezza del morso	Gewicht Weight Poids Peso Peso	Schliessdruck Closing pressure Pression d'Occlusion Presión de cierre Pressione di chiusura
41.0090	A	47 mm	10 mm	3 g	180
41.0091	D	44 mm	10 mm	3 g	180
41.0092	B	51 mm	14 mm	3 g	180
41.0093	E	46 mm	14 mm	3 g	180
41.0094	C	57 mm	20 mm	3 g	180
41.0095	F	49 mm	20 mm	3 g	180
41.0099	G	54 mm	20 mm	3 g	180



DEBAKEY

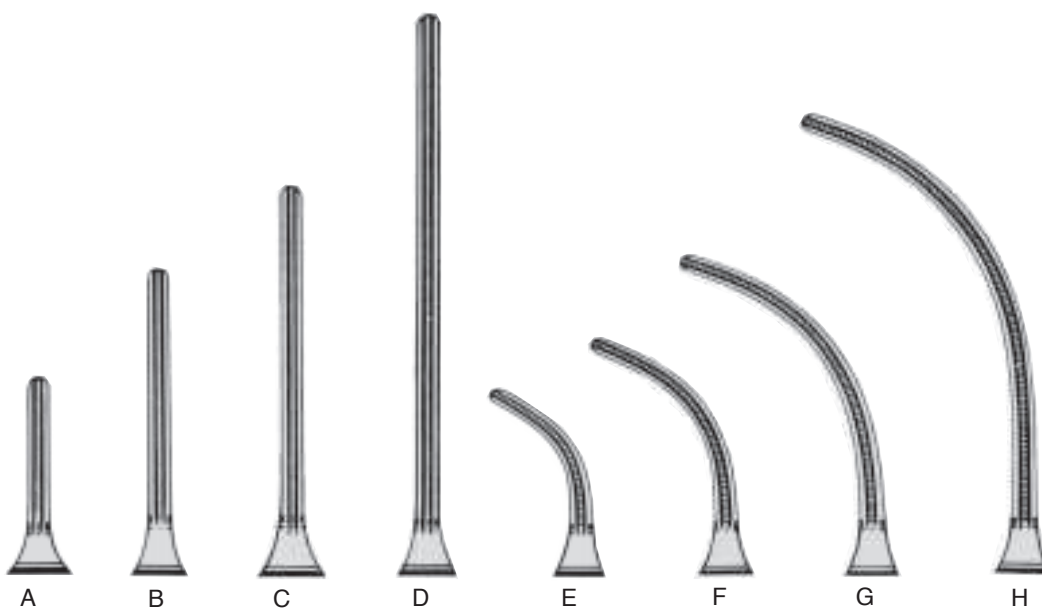

Artikel Item	Fig.	Gesamtlänge Overall length Longeur complet largo total Lunghezza total	Maullänge Jaw length longeur de mors largo de boca Lunghezza del morso	Gewicht Weight Poids Peso Peso
41.0100	A	80 mm	20 mm	10 g
41.0101	E	75 mm	20 mm	10 g
41.0110	B	90 mm	30 mm	11 g
41.0111	F	85 mm	30 mm	11 g
41.0115	C	105 mm	45 mm	12 g
41.0116	G	95 mm	45 mm	12 g
41.0120	D	125 mm	68 mm	12 g
41.0121	H	115 mm	68 mm	12 g



DEBAKEY
41.0130
12.5 cm



DEBAKEY
41.0132
12.5 cm



DEBAKEY
41.0134
12.5 cm 45°



DEBAKEY
41.0136
10 cm 90°



DEBAKEY
41.0138
12.5 cm



DEBAKEY-SATINSKY

41.0140 5,5 cm

41.0144 6,5 cm

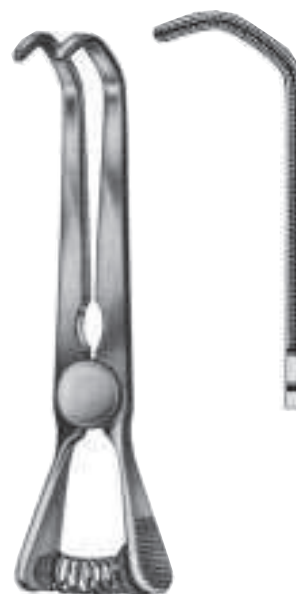

DEBAKEY-SATINSKY

41.0146 10 cm



DEBAKEY-CAROTID

41.0147 9 cm



CARREL
15.0098 8,5 cm



HARTMANN
10 cm



15.0100



15.0108
glattes Maul
smooth jaws
lisses
lisas
liscio



HARTMANN
15.0101 10 cm



HARTMANN-MICRO
15.0102 10 cm



HARTMANN-MICRO
15.0103 10 cm



HARTMANN
15.0104 10 cm 1x2



HARTMANN
15.0105 10 cm 1x2

TITANIUM



JACOBSON-MICRO
15.0116 12,5 cm

15.0117

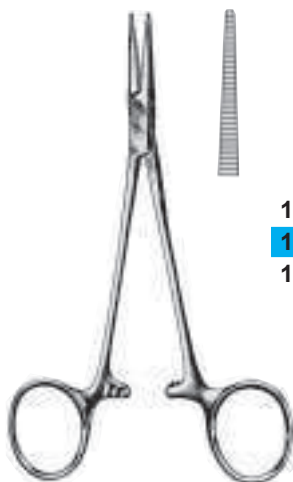

MOSQUITO
15.0120 12,5 cm
15.0120L 12,5 cm
15.0120T 12,5 cm
15.0124 14 cm

15.0121 12,5 cm
15.0121T 12,5 cm
15.0125 14 cm



15.0121L



MICRO-MOSQUITO
15.0122 12,5 cm

15.0123



MICRO-MOSQUITO
15.0128 12 cm 1x2

15.0129 1x2



MOSQUITO
15.0126 12,5 cm 1x2
15.0136 14 cm 1x2

15.0127 12,5 cm 1x2
15.0137 14 cm 1x2



MICRO-MOSQUITO
15.0139 12,5 cm
kreuzgerieft / cross-serrated
rainures croisées
estriada en forma de cruz
striatura cruciforme

TITANIUM



PROVIDENCE-HOSPITAL
 15.0130 14,5 cm



DUNHILL
 15.0180 12,5 cm



KELLY
 15.0200 14 cm
 15.0200T 14 cm



CRILE
 15.0210 14 cm
 15.0210T 14 cm



15.0211
 15.0211T

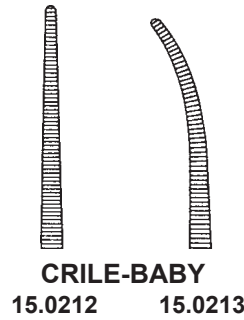

CRILE-BABY
 15.0212 15.0213

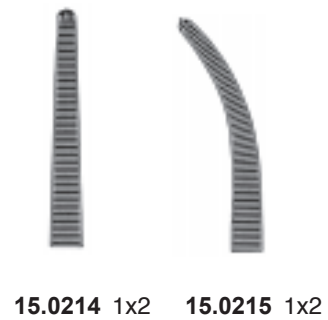

15.0214 1x2 15.0215 1x2



DANDY-MOSQUITO
15.0218 12 cm



DANDY
14,5 cm

15.0220

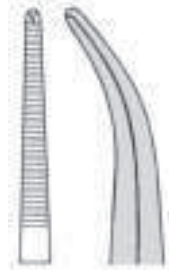

15.0222 1x2



LOVELACE
15,5 cm

15.0224

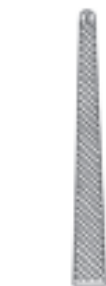

15.0225 1x2



LERICHE
15 cm

15.0230



15.0231



15.0236 1x2



15.0237 1x2



15.0240



15.0241

RANKIN-KELLY
16 cm



15.0251



RANKIN-CRILE
15.0250 16 cm



15.0253
1x2

RANKIN-CRILE
15.0252 16 cm 1x2



15.0260
14 cm



15.0262
16 cm



15.0261
14 cm



15.0263
16 cm



COLLER-CRILE

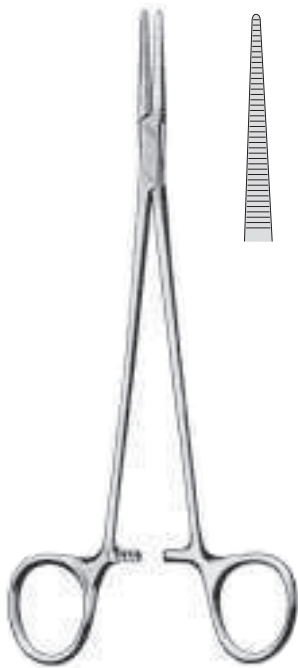

HALSTED

15.0300 18 cm

15.0302 21 cm

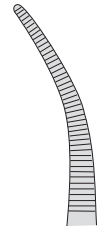

15.0301 18 cm

15.0303 21 cm



15.0306 18 cm 1x2

15.0308 21 cm 1x2

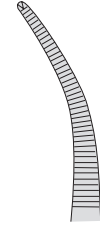

15.0307 18 cm 1x2

15.0309 21 cm 1x2



ADSON-BABY

15.0313 14 cm



15.0315

18 cm



ADSON

15.0310 18,5 cm

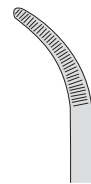

15.0311

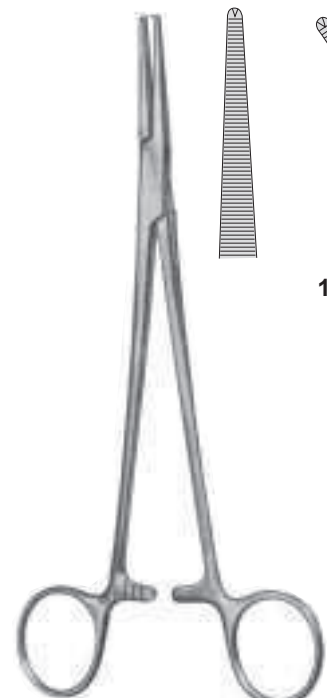

ADSON

15.0316 18,5 cm 1x2

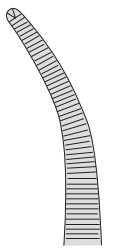

15.0317 1x2



HEISS
 15.0320 20 cm



15.0321 15.0323 15.0324 15.0325
 1x2 1x2



FUCHSIG
 15.0331 18,5 cm



NISSEN
 15.0335 19 cm

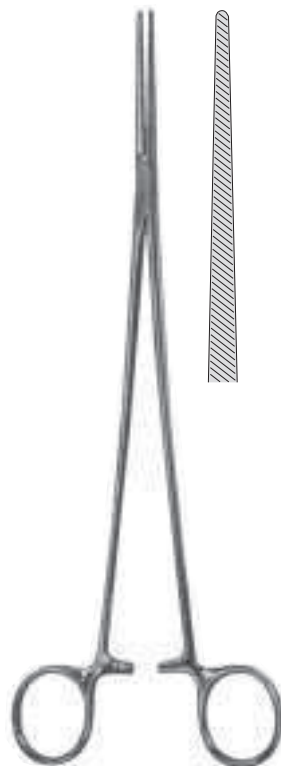

BENGOLEA
 15.0360 20 cm
 15.0362 26 cm

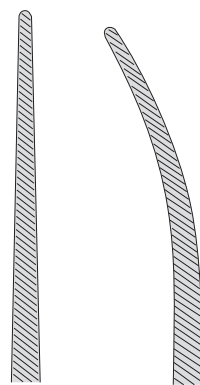

15.0361 20 cm
 15.0363 26 cm

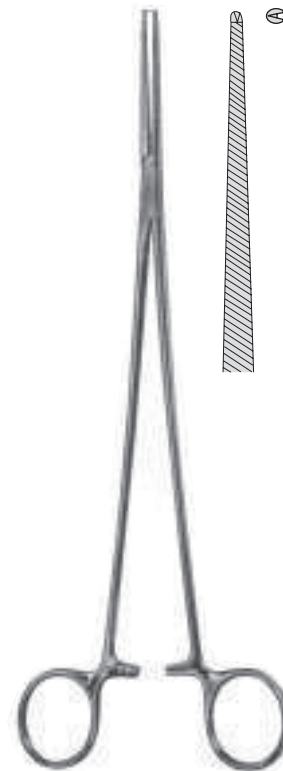

BENGOLEA
 15.0364 20 cm 1x2
 15.0366 26 cm 1x2

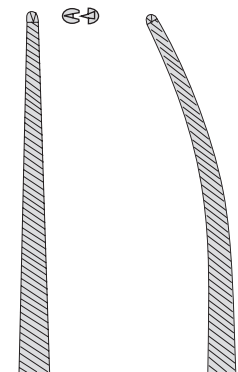

15.0365 20 cm 1x2
 15.0367 26 cm 1x2



BRIDGE
15.0392 28 cm



15.0393
28 cm

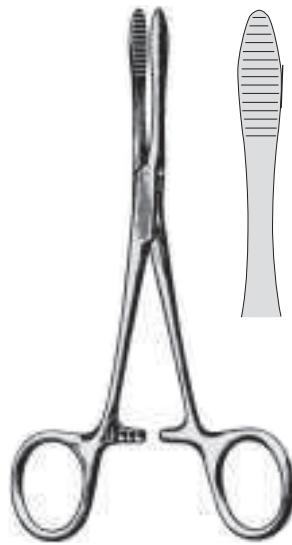

PEAN
15.0404 12,5 cm
15.0406 14,5 cm
15.0408 16 cm



SPENCER-WELLS
15.0410 13 cm
15.0412 14 cm
15.0414 15 cm
15.0416 18 cm
15.0418 20 cm

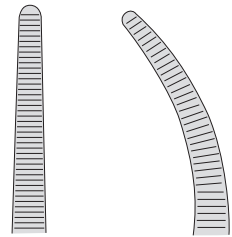

SPENCER-WELLS
15.0411 13 cm
15.0413 14 cm
15.0415 15 cm
15.0417 18 cm
15.0419 20 cm



ROCH-CARMALT
15.0430 16 cm
15.0432 20 cm

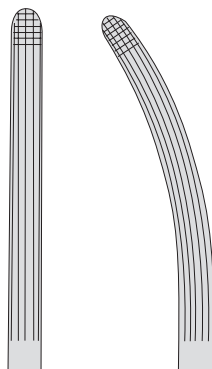

15.0431 16 cm
15.0433 20 cm



BAINBRIDGE
15.1320 15,5 cm
15.1322 18,0 cm

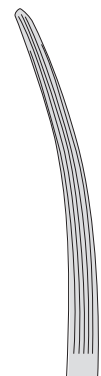

15.1321 15,5 cm
15.1323 18,0 cm

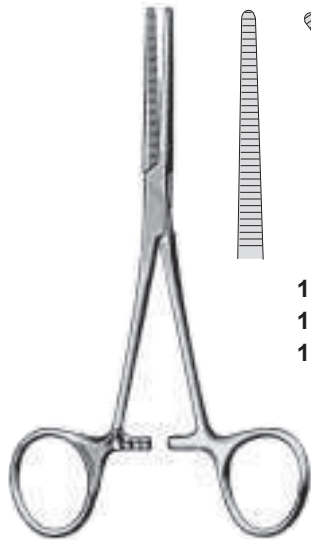

15.0451 13 cm
15.0453 14 cm
15.0455 16 cm

PEAN-FINO

15.0450 13 cm
15.0452 14 cm
15.0454 16 cm



15.0459 13 cm
15.0461 14 cm
15.0463 16 cm
15.0465 18 cm
15.0467 20 cm
15.0469 22 cm
15.0471 24 cm
15.0473 26 cm
15.0477 30 cm

ROCHESTER-PEAN

15.0458 13 cm
15.0460 14 cm
15.0462 16 cm
15.0464 18 cm
15.0466 20 cm
15.0468 22 cm
15.0470 24 cm
15.0472 26 cm
15.0476 30 cm



15.0481

ROBERTS

15.0480 22 cm



OLIVECRONA

15.0482
18 cm

15.0484
20 cm

15.0486
24 cm



CRAFOORD

15.0492
18 cm

15.0493
20 cm

15.0494
24 cm



CRAFOORD-SELLORS
24 cm

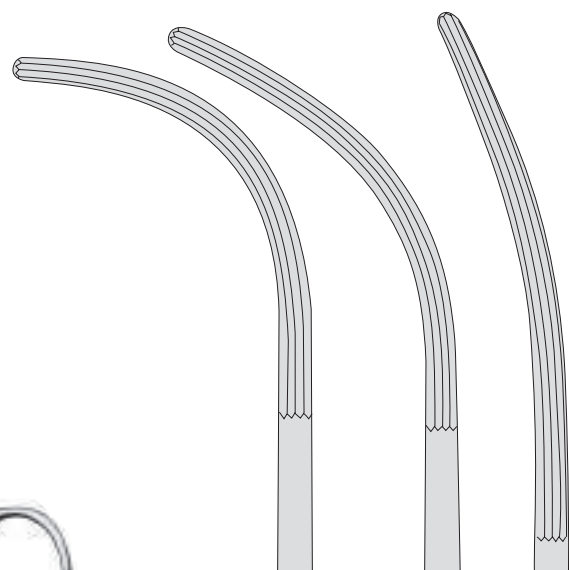

15.0495

15.0496

15.0497



SAROT
 15.0500 24 cm



15.0501



ZENKER
 15.0521 29,5 cm



15.0523



KELLY

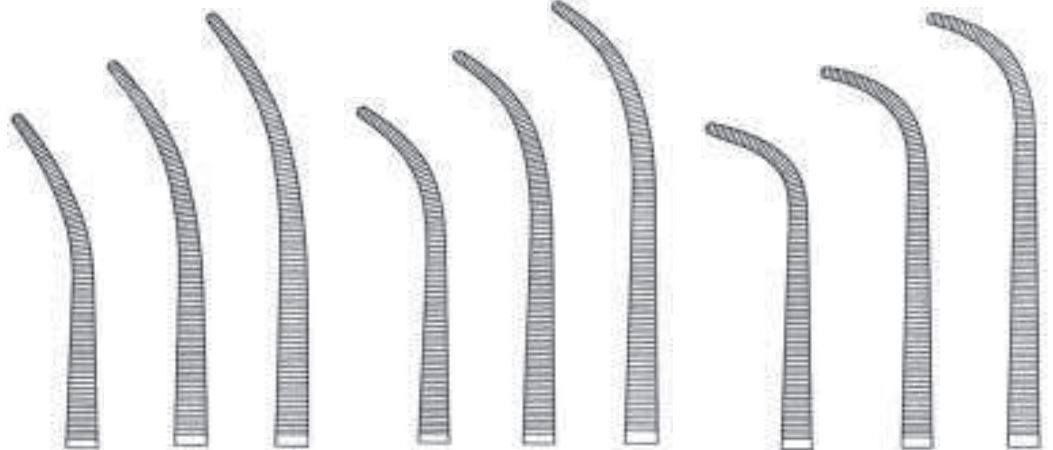

15.0531	15.0532	15.0533	15.0534	15.0535	15.0536	15.0537	15.0538	15.0539
19 cm	22 cm	24 cm	19 cm	22 cm	24 cm	19 cm	22 cm	24 cm

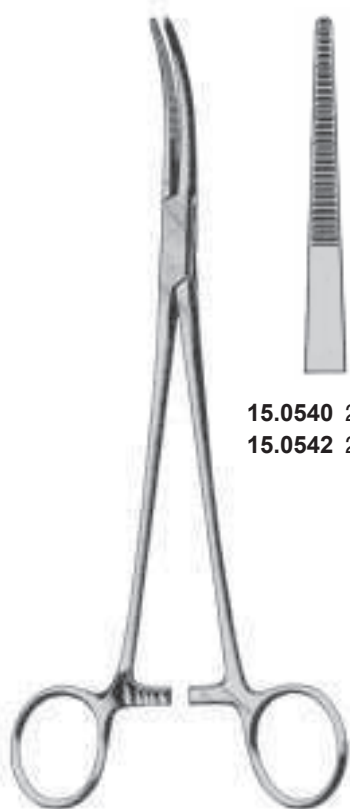

15.0540 21 cm
15.0542 26 cm



15.0541 21 cm
15.0543 26 cm



15.0546 21 cm 1x2
15.0547 26 cm 1x2



15.0548 21 cm 1x2
15.0549 26 cm 1x2

TOENNIS

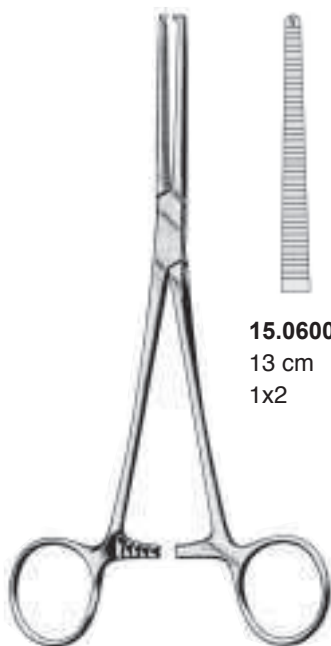

15.0600
13 cm
1x2



15.0601
13 cm
1x2



15.0602
14,5 cm
1x2



15.0603
14,5 cm
1x2



15.0604
16 cm
1x2



15.0605
16 cm
1x2



15.0607 14 cm
15.0609 16 cm

KOCHER

KOCHER-FINO

15.0606 14 cm
15.0608 16 cm



ROCHESTER-OCHSNER

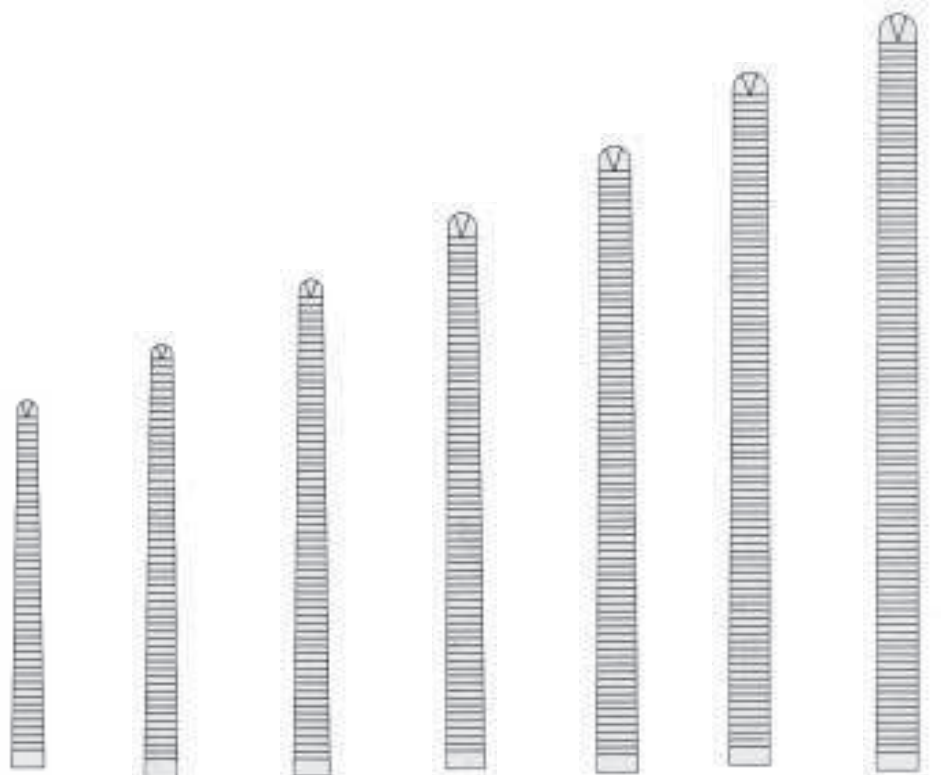

15.0620	15.0622	15.0624	15.0626	15.0628	15.0630	15.0632
16 cm	18 cm	20 cm	22 cm	24 cm	26 cm	30 cm
1x2	1x2	1x2	1x2	1x2	1x2	1x2

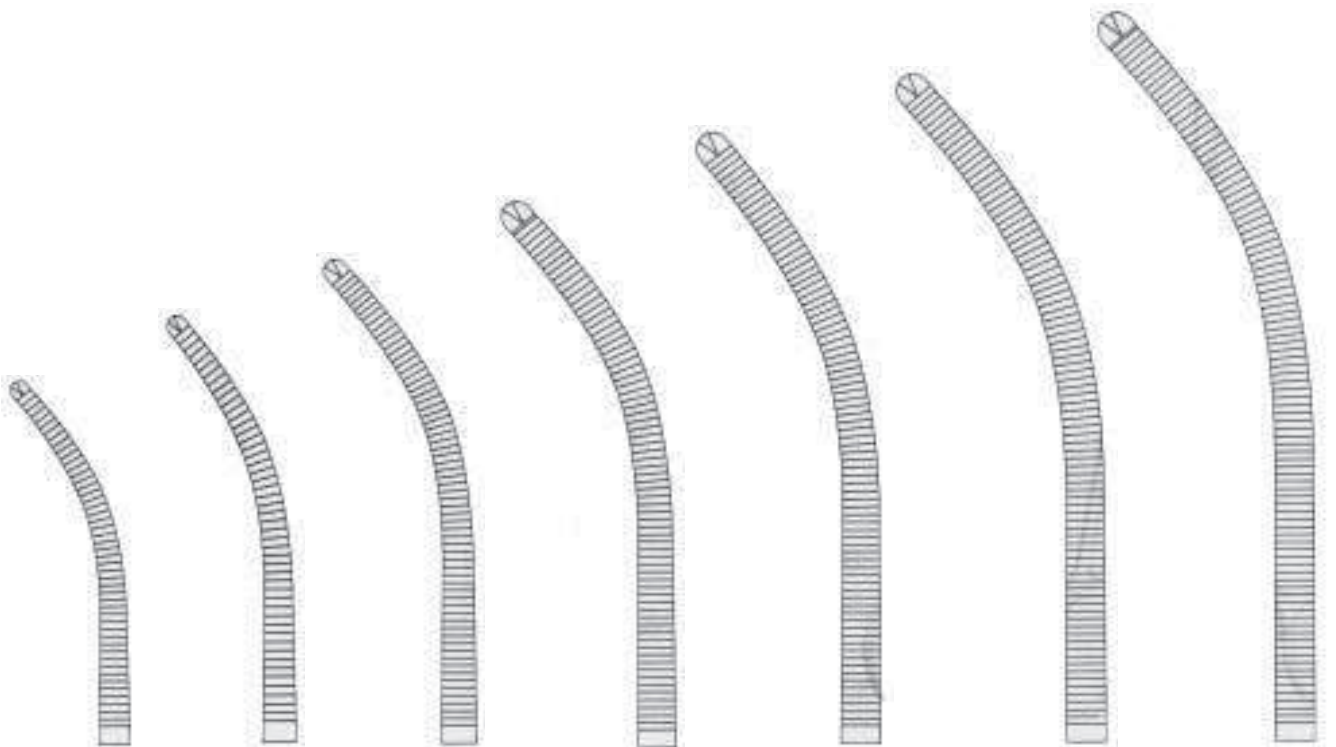

15.0621	15.0623	15.0625	15.0627	15.0629	15.0631	15.0633
16 cm	18 cm	20 cm	22 cm	24 cm	26 cm	30 cm
1x2	1x2	1x2	1x2	1x2	1x2	1x2



MIXTER-O'SHAUGHNESSY

15.0701 15 cm

15.0703 19 cm



OVERHOLT-BABY

15.0720 14 cm

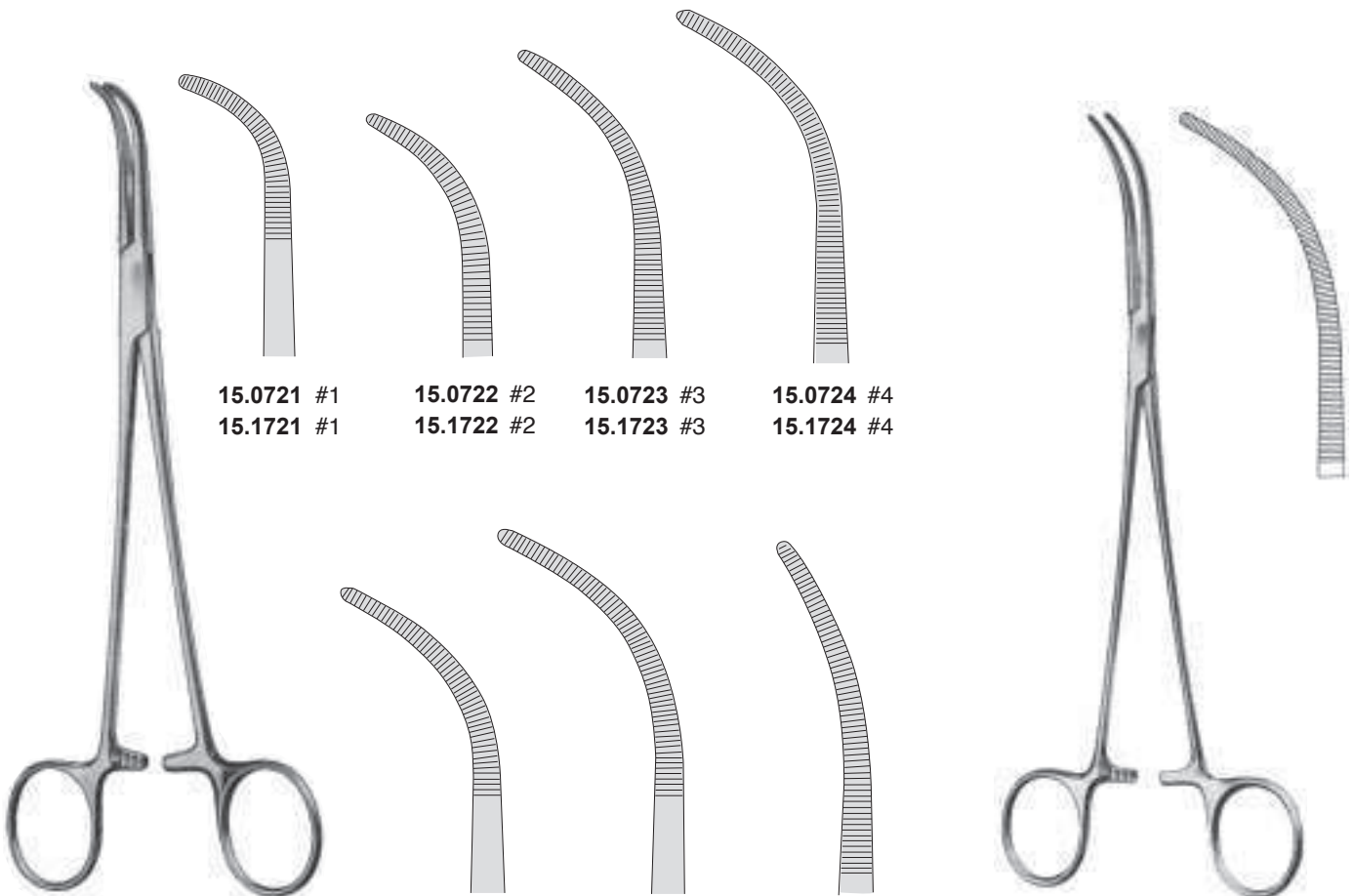

15.0721 #1

15.1721 #1

15.0722 #2

15.1722 #2

15.0723 #3

15.1723 #3

15.0724 #4

15.1724 #4

OVERHOLT-GEISSENDOERFER

15.0721-15.0727 21 cm

15.1721-15.1727 27 cm

15.0725 #5

15.1725 #5

15.0726 #6

15.1726 #6

15.0727 #7

15.1727 #7

OVERHOLT-MIXTER

15.0729 21 cm

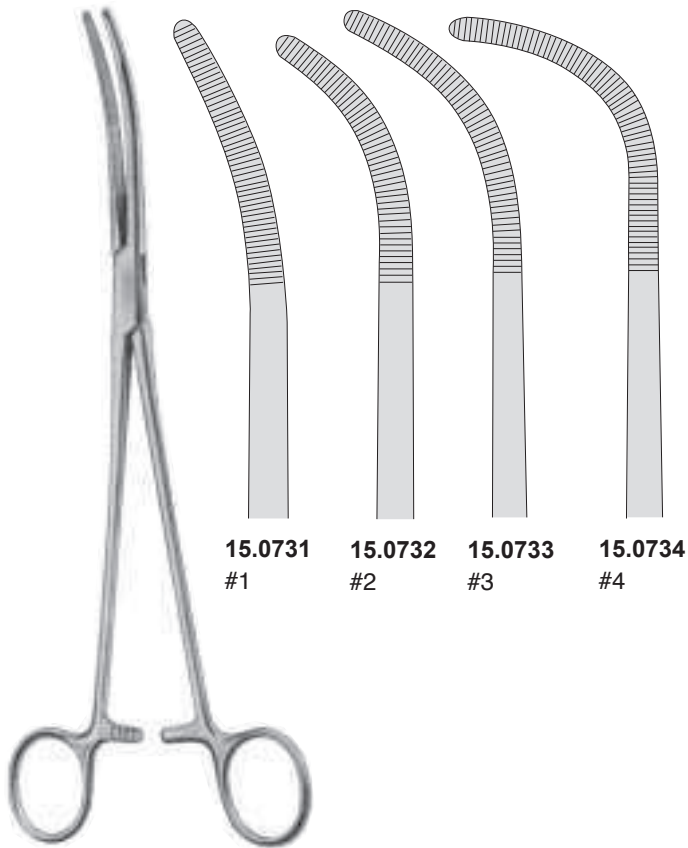

RUMEL
23 cm



KANTROWITZ

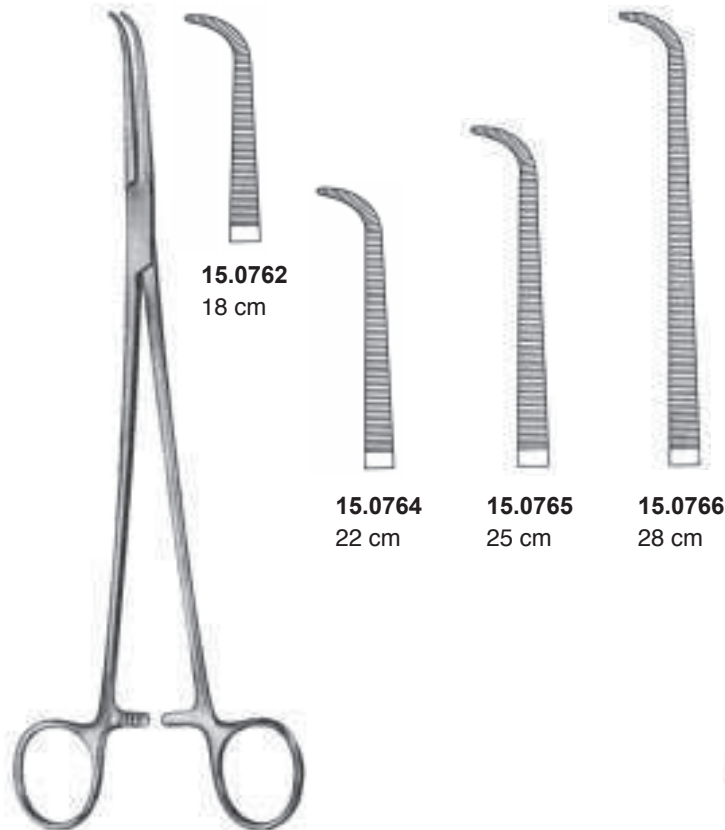

GEMINI-MINI

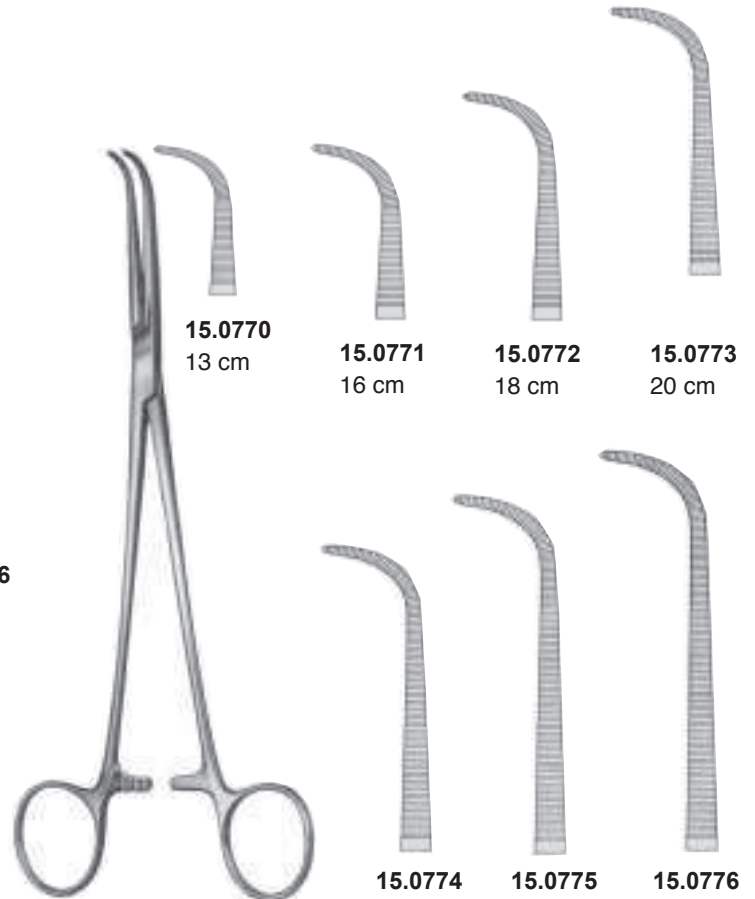

GEMINI



WIKSTROEM
15.0780 21 cm
15.0782 24 cm



LAWRENCE
15.0784 28 cm



MEEKER
15.0786 28 cm



MIXTER-BABY
15.0801 14,5 cm



MIXTER-BABY
15.0803 18 cm



MIXTER
 15.0807 22 cm



MIXTER
 15.0809 23 cm



MIXTER

15.0811
 16 cm



15.0813
 19 cm



15.0817
 23 cm



MIXTER

15.0831
 22 cm

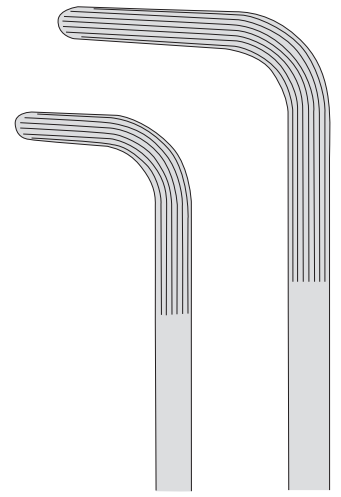

15.0833
 25 cm

15.0835
 28 cm



SCHNIDT
 34.0303
 19 cm



SAWTELL
 34.0305
 19 cm



SCHNIDT
 34.0307
 19 cm



SAWTELL
 34.0309
 19 cm



NEGUS
 19 cm



34.0311



34.0313



WHITE
 34.0321 18 cm
 34.0323 23 cm



34.0330
18,5 cm

BIRKETT



34.0331
18,5 cm



BALLENGER
34.0333
21,5 cm



BLOHMKE
34.0335
20 cm



MARSHIK
34.0350
22 cm



COLVER
19 cm



34.0327



34.0329



HARRINGTON
40.0701
30,5 cm



HARRINGTON
40.0702
29,5 cm



40.0713
Zähne links
teeth on left
dents à gauche
dientes a la izquierda
denti sinistro

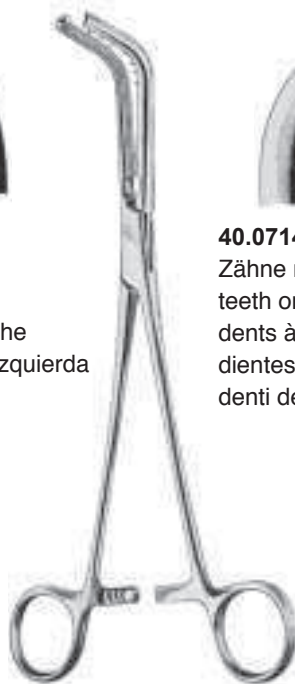

SAROT
23 cm



40.0714
Zähne rechts
teeth on right
dents à droite
dientes a la derecha
denti destro



FINOCCHIETTO
40.0720
24 cm



40.0730

PRICE-THOMAS

22 cm



40.0731

Zähne links
 teeth on left
 dents à gauche
 dientes a la izquierda
 denti sinistro

PRICE-THOMAS

22 cm



40.0732

Zähne rechts
 teeth on right
 dents à droite
 dientes a la derecha
 denti destro



BRONCHUS

23 cm



40.0740

60 mm



40.0742

80 mm



LOVELACE
40.0750
20 cm



LOVELACE
40.0751
20 cm



SEMB



40.0761
24 cm #1



40.0763
24 cm #2



SATINSKY
40.0900
15 cm

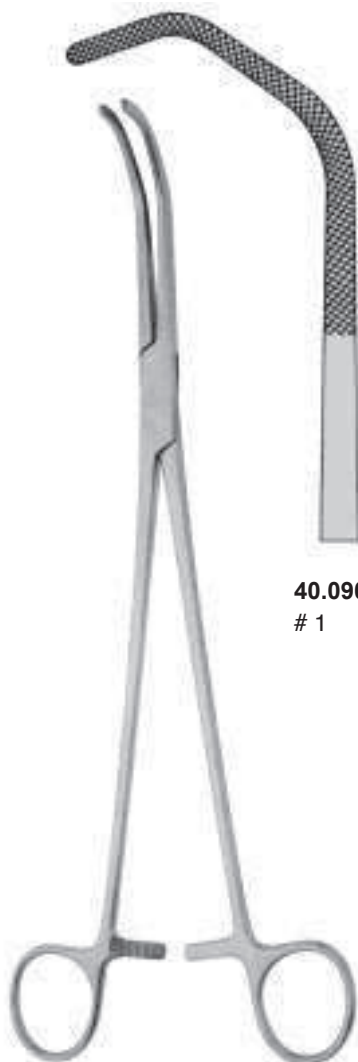

40.0902
1



40.0904
2



CHAPUT
 15.1200 12 cm



TUFFIER
 15.1204 13 cm

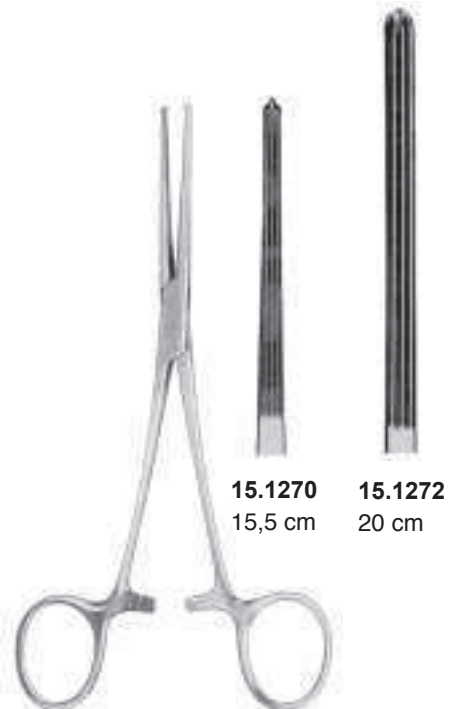

15.1270 15,5 cm
15.1272 20 cm

ALLEN-KOCHER



PENNINGTON
 15.1300 15 cm
 15.1302 20 cm



ALLIS-BABY
 48.0004 13 cm, 4 x 5
 48.0006 14 cm, 4 x 5



ALLIS

48.0010
 15 cm, 4 x 5

48.0011
 15 cm, 5 x 6
48.0014
 19 cm, 5 x 6
48.0016
 25 cm, 5 x 6

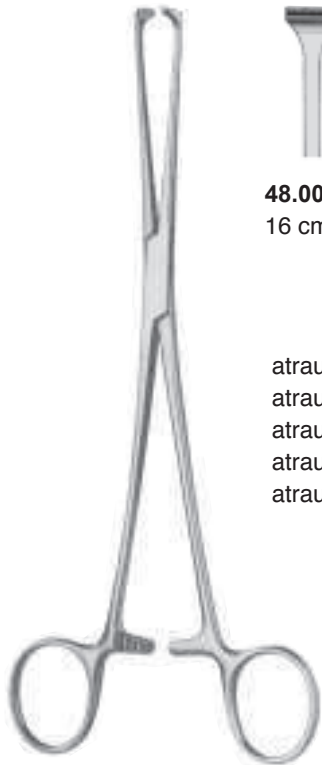

ALLIS

48.0020
16 cm

atraumatisch
 atraumatic
 atraumatique
 atraumática
 atraumatiche

48.0024
20 cm

48.0028
25 cm

48.0029
30 cm



ALLIS-ADAIR
48.0030 15,5 cm



JUDD-ALLIS
48.0032 15 cm
48.0034 19 cm
3 x 4



LITTLEWOOD
48.0035 19 cm
2 x 3



BOYS-ALLIS
48.0036 15 cm



THOMS-ALLIS
48.0038 20 cm
6 x 7



LOCKWOOD
48.0040 19,5 cm



OMBREDANNE
48.0050 13,5 cm



WILLIAMS
48.0045 16,5 cm



BABCOCK



48.0062
16 cm



48.0064
18 cm



48.0066
20 cm



48.0068
24 cm



BABCOCK



48.0072
16 cm



48.0076
20 cm



BABCOCK-DEBAKEY



48.0082
16 cm



48.0086
20 cm



48.0088
23 cm



COLLIN
48.0089
 14 cm



DUVAL



48.0090
 18 cm / 14 mm
48.0092
 20 cm / 14 mm



48.0094
 20 cm / 25 mm
48.0098
 23 cm / 25 mm



48.0094 AT
 20 cm / 20 mm
48.0098 AT
 23 cm / 25 mm

atraumatisch
 atraumatic
 atraumatique
 atraumática
 atraumatiche



DUVAL



48.0099
 20 cm / 15 mm





15.1580
25 cm



DEBAKEY



15.1582
27 cm



PRATT
15.1350 15 cm



KOCHER-BABY
13 cm

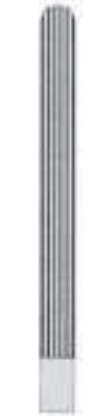

48.0100



48.0101

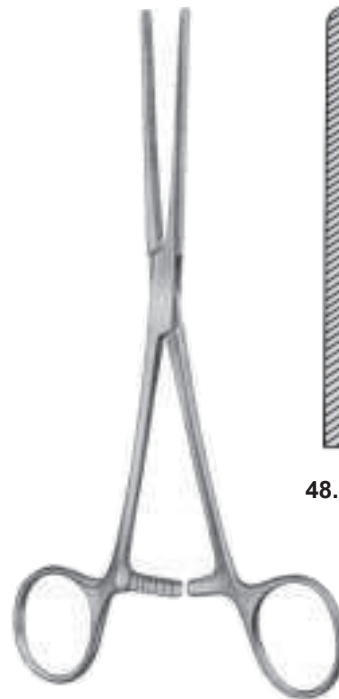

DOYEN
18 cm



48.0102



48.0103



DOYEN



48.0104 21 cm
48.0106 23 cm

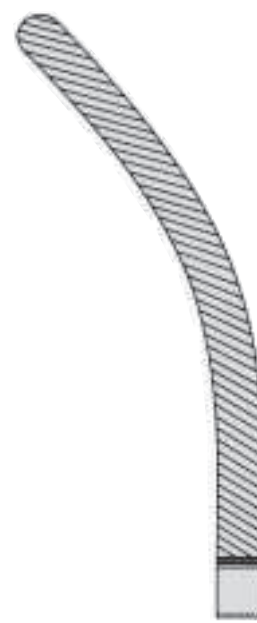

48.0105 21 cm
48.0107 23 cm

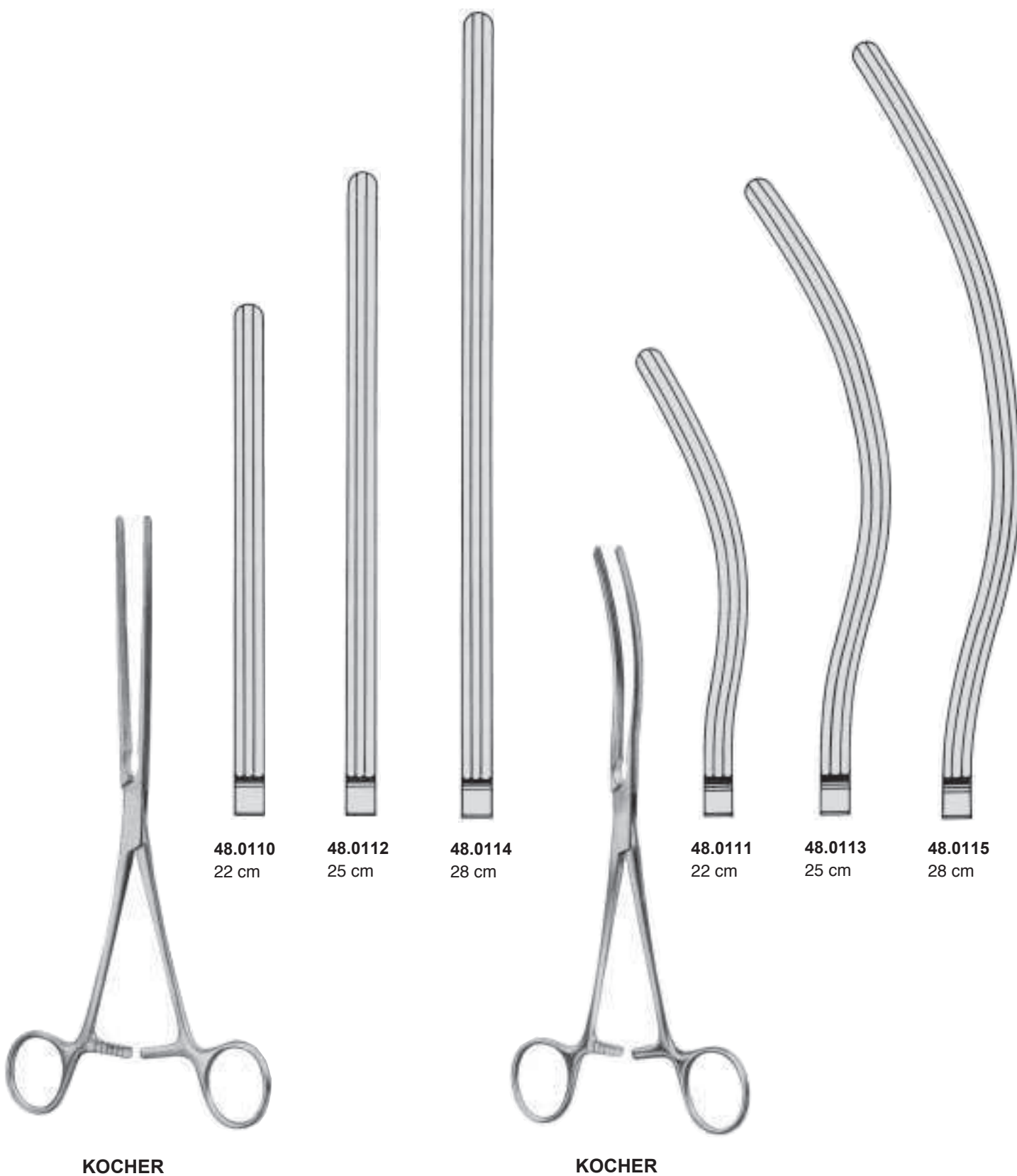

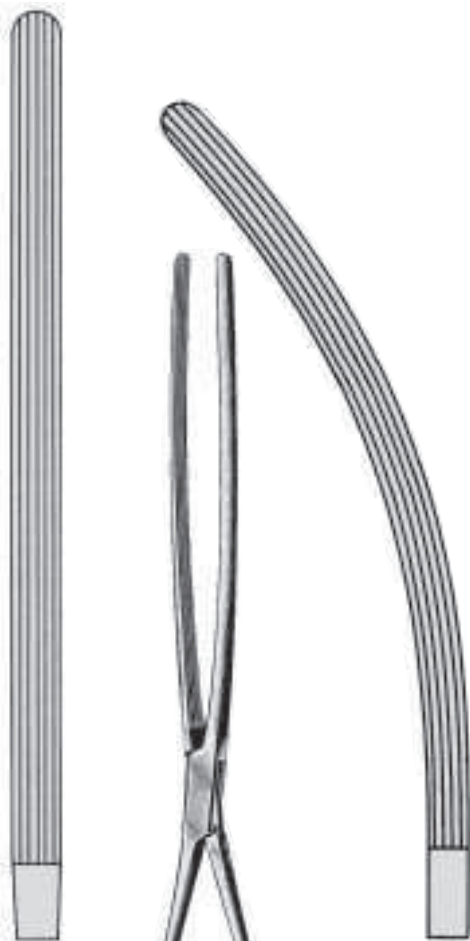

48.0118
25 cm

48.0119
25 cm



MAYO-ROBSON

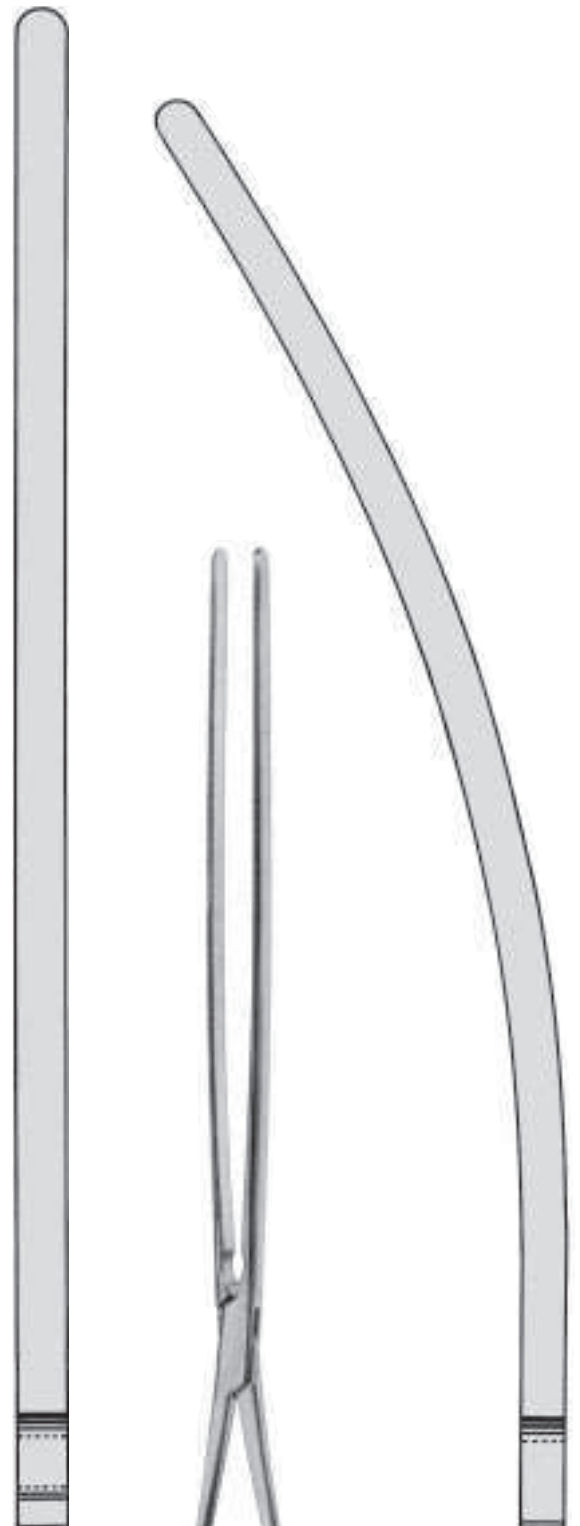

48.0120
33 cm

48.0121
33 cm



SCUDDER

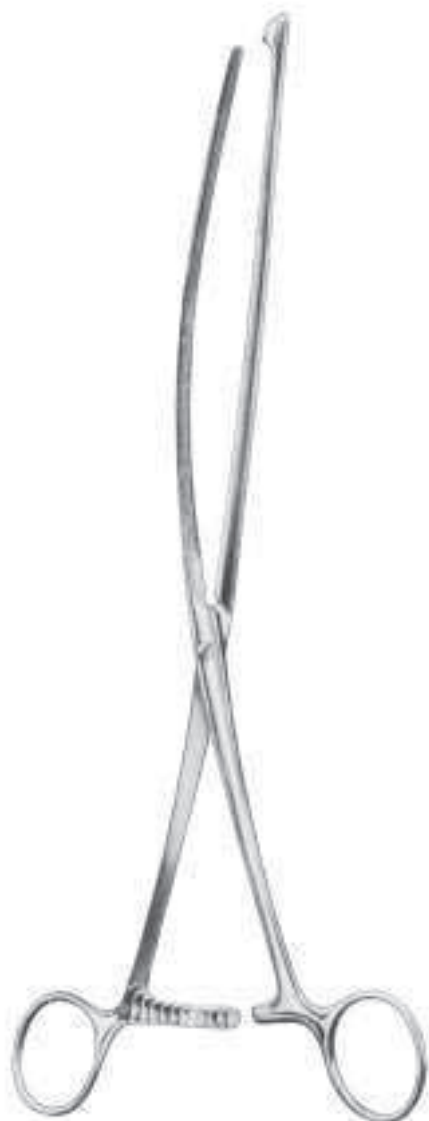

NUSSBAUM
25 cm

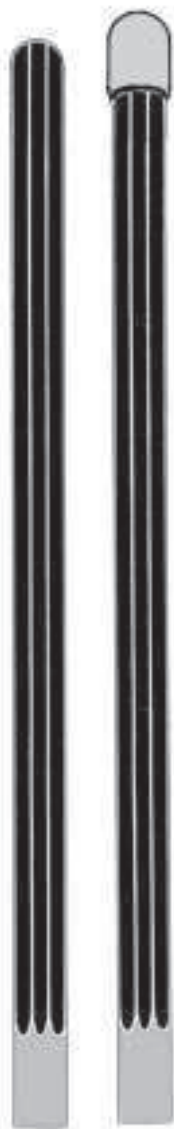

48.0122



48.0123



BRUNNER
48.0125 23 cm



48.0130
26,5 cm / 30 mm



48.0131
26,5 cm / 60 mm

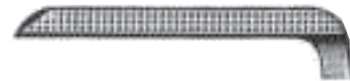

48.0132
26,5 cm / 75 mm



FEHLAND
48.0126 24 cm



BEST



LANE
48.0140 30 cm

LANE
48.0141 30 cm



48.0150 13 cm
 48.0152 16 cm

DOYEN-DEBAKEY



48.0151 13 cm
 48.0153 16 cm

DOYEN-DEBAKEY



48.0154 18 cm
 48.0156 21 cm
 48.0158 23 cm

DOYEN-DEBAKEY



48.0155 18 cm
 48.0157 21 cm
 48.0159 23 cm

DOYEN-DEBAKEY



KOCHER-DEBAKEY

48.0160 22 cm

48.0162 25 cm

48.0164 28 cm



KOCHER-DEBAKEY

48.0161 22 cm

48.0163 25 cm

48.0165 28 cm



HAYES-DEBAKEY



48.0170
26 cm / 55 mm

48.0172
28 cm / 85 mm



FEHLAND-DEBAKEY
48.0180 24 cm

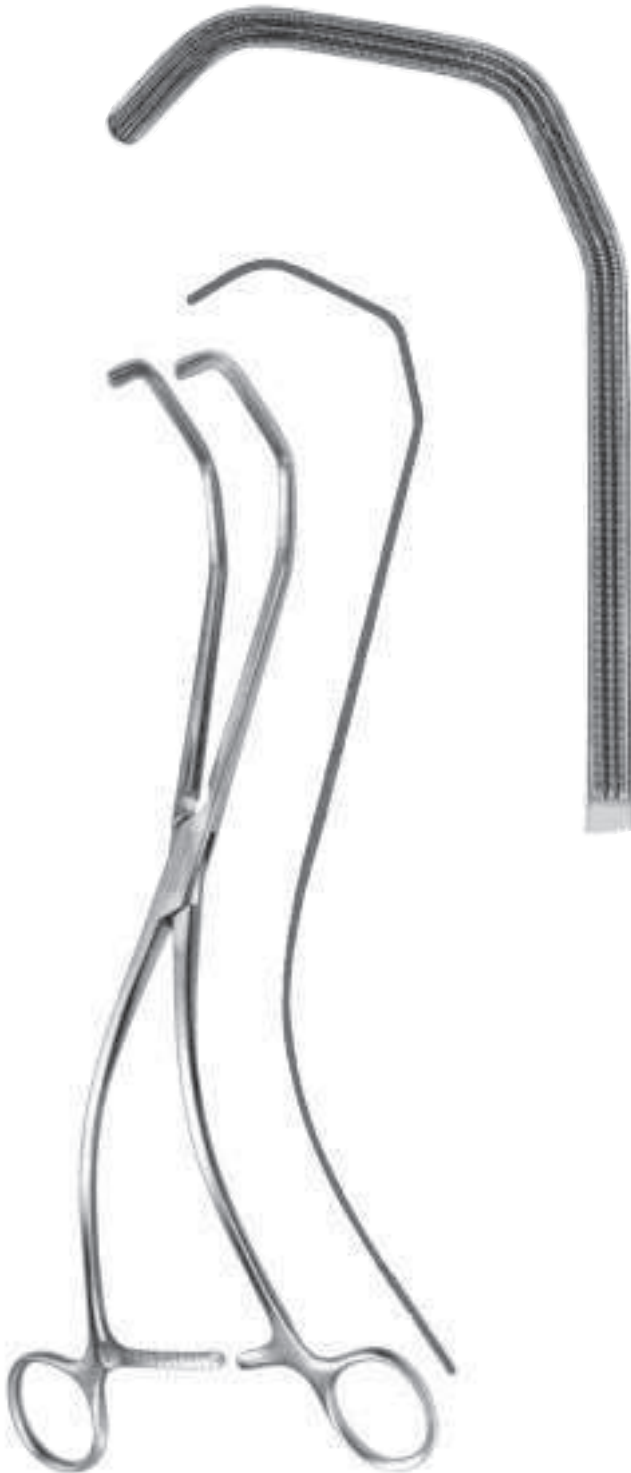

KERSTING
48.0184
31 cm



RESANO
48.0186
30 cm



SCUDDER-DEBAKEY
48.0190
33 cm



SCUDDER-DEBAKEY
48.0191
33 cm



48.0200
25 cm 0°



48.0204
28 cm 0°



48.0201
25 cm 15°



48.0205
28 cm 15°



48.0203
25 cm 30°

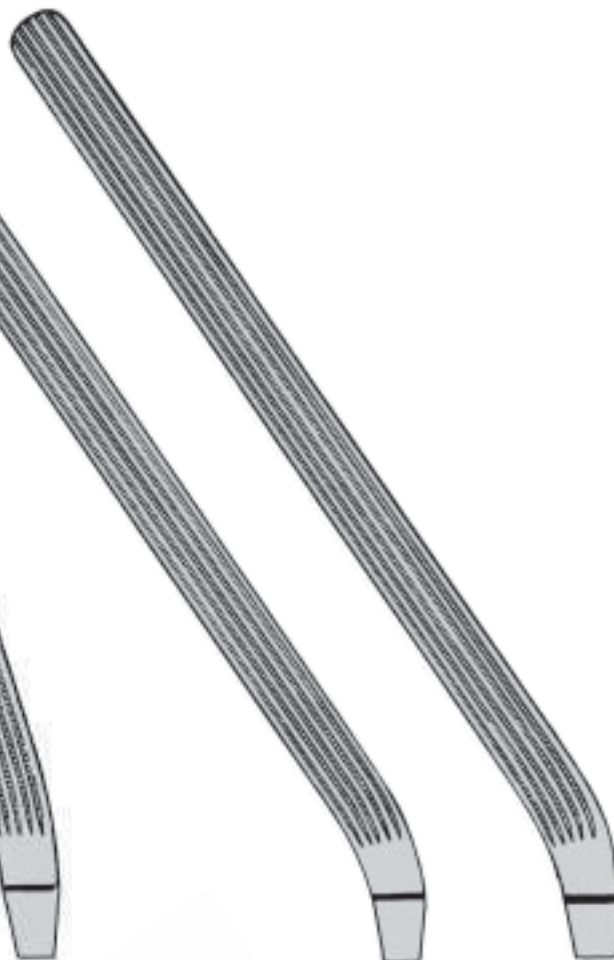

48.0207
28 cm 30°



MARINUS



BUIE
48.0300 21 cm



LLOYD-DAVIES
48.0350 31,5 cm



FERGUSSON

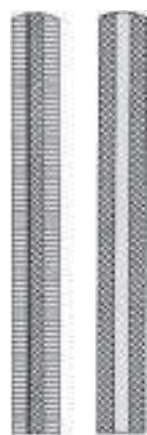

48.0312 20 cm

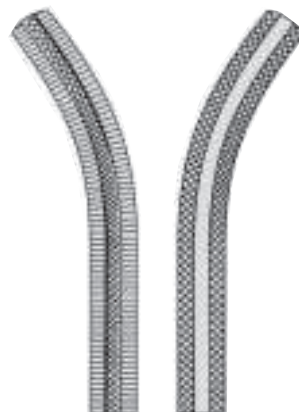

48.0313 20 cm



LAHEY
15.0841 19 cm
15.0843 23 cm



MOYNIHAN
15.0901 23 cm
15.0903 24 cm



DESJARDIN
15.0911 21 cm



DESJARDIN
15.0913 21 cm



LOWER
15.0931 18 cm



JOHNS-HOPKINS
15.0941 20 cm



MIXTER
15.1015 22 cm



GRAY
15.1031 22 cm #1



15.1033
23 cm #2



GRAY
15.1035 22 cm #1



15.1037
23 cm #2



BLAKE
20 cm

50.0300



50.0301



DESJARDINS
23 cm



50.0311
#1



50.0313
#2



DESJARDINS



50.0315
24 cm



50.0317
22,5 cm



MAYO-BLAKE
50.0320
20 cm



MAYO-BLAKE
50.0321
20 cm



MIXTER
50.0325
22 cm



DOYEN
50.0330
20 cm



MAYO-GUYON
15.1930 23 cm



GUYON

15.1931
20 cm



15.1933
22 cm



15.1935
24 cm



GUYON
15.1937 23 cm



STILLE
15.1940 23 cm



HERRICK
15.1960 23 cm



50.0340
 23 cm #1



50.0342
 21 cm #2



50.0344
 19 cm #3



50.0346
 18 cm #4

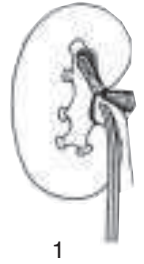

1



2



3



4



5 / 6

RANDALL

50.0347

Satz #1-4 / Set #1-4 /

Jeu #1-4 / Juego #1-4 / Serie di #1-4



RANDALL



50.0348
 19 cm #5



50.0350
 19 cm #6



URO

24 cm

Ureterzangen
Ureter Forceps
Pincés pour urètre
Pinzas para uréter
Pinze per uretere



50.0401
1



50.0402
2



DARTIGUES

55.1520

27 cm

Nierenfaßzange
Kidney elevating forceps
Hystérolabe
Pinza para sostener el riñón
Pinze per afferare il rene

Prostata-Fasszange
Prostatic grasping forceps
Pince à saisir la prostate
Pinza para coger prostata
Pinza per afferare la prostata



YOUNG
51.0004
20 cm

Samenstrang-Fixierklemme
Spermatic cord fixation clamp
Pince pour fixer le canal déférent
Pinza-fixajion canal espermatica
Pinza per fissare il tronco spermatico



SPERMATIC
51.0040
14,5 cm

Ureterklemmen
Ureter clamps
Pinces à urètere
Pinzas clamps para ureter
Pinze per uretere



51.0042
21 cm #2

LURZ
51.0041
21 cm #1



WERTHEIM
 15.2125
 24 cm 1x2



15.2200
 18 cm

15.2202
 20 cm

MIKULICZ



15.2209
 20 cm

15.2211
 20 cm

MIKULICZ



MIKULICZ-BABY
 15.2215 14 cm



15.2221

15.2223

FAURE
 20 cm



FAURE
 15.2225 25 cm



PHANEUF

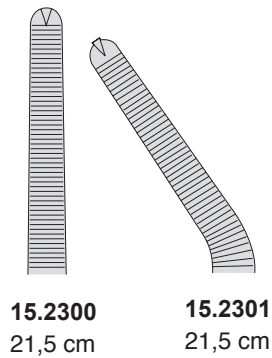

15.2300
21,5 cm

15.2301
21,5 cm

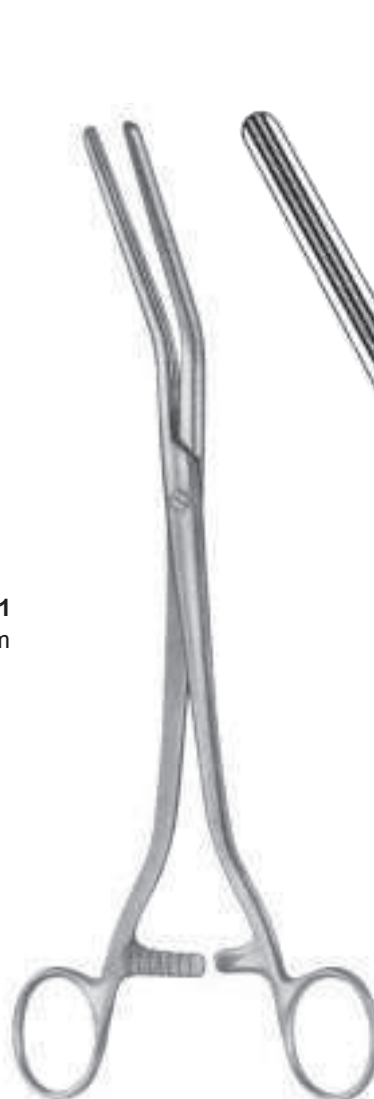

DICK

Druckklemmen
Pressure Clamps
Pinces à pression
Pinzas de presión
Pinze de pressione

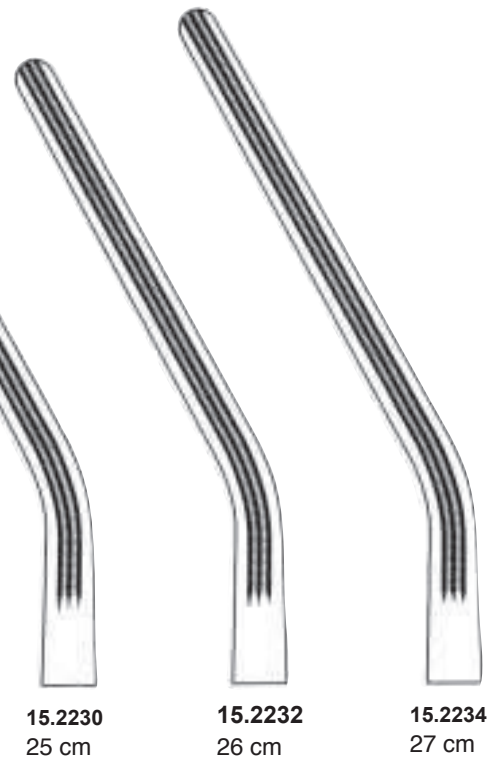

15.2230
25 cm

15.2232
26 cm

15.2234
27 cm



HEANEY-KANTOR

15.2311 20 cm
15.2313 23 cm



HEANEY-REZEK

15.2314 23 cm



HEANEY

15.2315 20 cm
15.2317 23 cm



WERTHEIM

15.2321 25 cm



**SECOND-
LANDAU**

15.2324
24 cm



SECOND

15.2325
24 cm



WERTHEIM-CULLEN
15.2340 21,5 cm



WERTHEIM-ATRAUMA
15.2344 21 cm

atraumatisch
atraumatic
atraumatique
atraumática
atraumatiche



15.2345
22 cm
1x2

15.2347
22 cm
1x2



15.2348
22 cm
1x2

15.2349
22 cm
1x2

WERTHEIM

WERTHEIM



15.2360
22 cm



15.2361
22 cm



15.2362
21 cm



15.2363
20 cm



WERTHEIM-DEBAKEY



15.2365
25 cm



15.2366
25 cm



15.2367
25 cm



15.2368
24 cm

HAKENZANGEN

TENACULUM FORCEPS

PINCES POUR ABAISSEMENT DU COL UTERIN

PINZAS PARA COGER EL CUELLO DEL UTERO

PINZE PER ABBASSARE EL COLLO DELL'UTERO

PRO-MED



BARRETT
55.0930
18 cm



STAUDE-MOORE
55.0932
17 cm



BRAUN
55.0934
25 cm



CZERNY
55.0936
21 cm



ADAIR
55.0938
19 cm



SCHROEDER
55.0940
25 cm



POZZI
55.0944
25 cm



DUPLAY
55.0947
28 cm



HULKA
55.0948
29 cm



HULKA-KENWICK
55.0949
29 cm



SKENE
55.0951
24 cm



TIEMANN
55.0956
22 cm

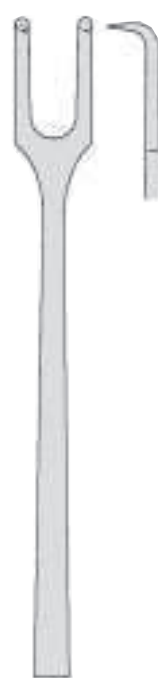

55.0962
2 x 2



55.0963
2 x 2



SCHROEDER
24 cm



55.0971

HENROTIN
55.0965
21 cm 2 x 3

PRATT
55.0968
28 cm

JACOBS
55.0970
21 cm



TEALE

55.0973 18 cm 3 x 4

55.0975 23 cm 3 x 4



KÜSTNER

55.0977 25 cm 2 x 3



MUSEUX

55.0980 24 cm / 6 mm

55.0982 24 cm / 8 mm

55.0984 24 cm / 10 mm



6 mm

8 mm

10 mm

55.0981 24 cm / 6 mm

55.0983 24 cm / 8 mm



SOMER
55.1500
23 cm



COLLIN
551510
25 cm



COLLIN
55.1511
25 cm



DARTIGUES
55.1520
27 cm

Klemmzange / Uterine Hémostatic Forceps /
Pince-Clamp utérine / Pinza-Clamp uterina / Pinza-Clamp uterina



GREEN-ARMYTAGE
56.0800 22 cm



GREEN-ARMYTAGE
56.0801 20 cm

Kopfschwartzangen / Scalp flap forceps / Pincés pour le
quir chevelu / Pinzas para pericráneo / Pinze per pericráneo



MARTEL
15.1340 14 cm



WILLET
15.1342 19 cm



GAUSS
56.0805 26 cm

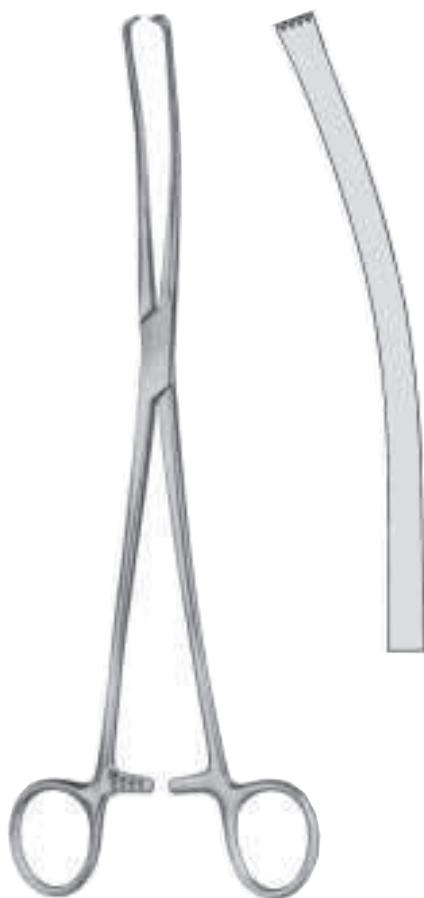

Blasensprenger /
Membrane puncturing forceps /
Pince perce-membrane /
Pinza rompe membrana /
Pinza rompere membrana

IOWA
56.0820 26 cm



HEYWOOD-SMITH
56.0880 21 cm
56.0882 25 cm

Uterus-Polymenzangen / Uterine Polypus Forceps /
Pinces à polypes utérines / Pinzas para pólipos uterinos /
Pinze per polipi uterini



DOYEN
56.0890 20 cm

Uterus-Polymenzangen / Uterine Polypus Forceps /
Pinces à polypes utérines / Pinzas para pólipos uterinos /
Pinze per polipi uterini



NOTO
56.0896 27 cm



BUMM
56.0898 28 cm

Plazentar- und Abortuszangen / Placenta- and Ovum Forceps / Pincers à faux germes /
 Pinzas para aborto y placenta / Pinze per aborto e placenta



KELLY
 56.0900 32 cm

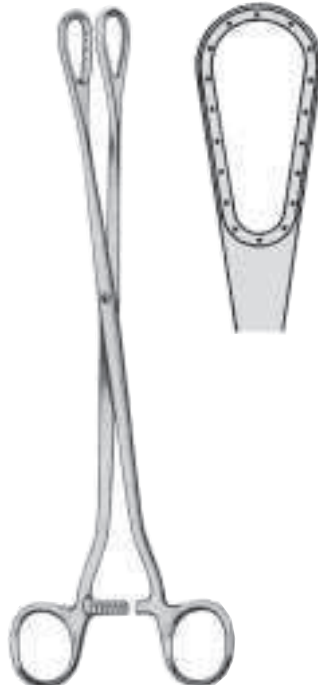

SAENGER
 56.0910 27 cm

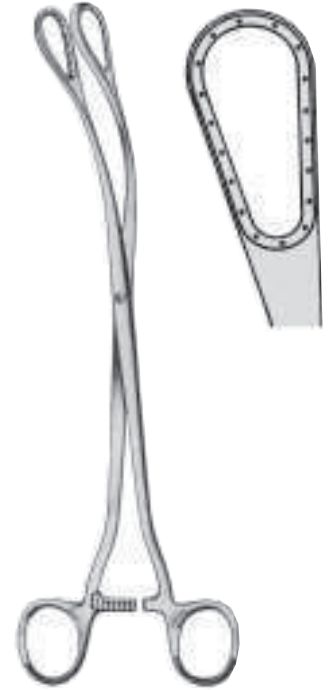

SAENGER
 56.0911 27 cm



WINTER
 29 cm



56.1000
 #1



56.1002
 #2



56.1004
 #3



WINTER
 29 cm



56.1001
 #1



56.1003
 #2



56.1005
 #3